



SLX[®] 3x MICROPRISM[™]

OPTIC MANUAL

THANK YOU FOR CHOOSING THIS PRIMARY ARMS OPTIC

If you have any questions about your new optic or any of our other products, visit us at www.primaryarmsoptics.com, email us at info@primaryarmsoptics.com, or give us a call toll-free at 855-774-2767. The customer service team at our headquarters in Houston, Texas will respond promptly.

If you have any problems with a Primary Arms Optics product, we urge you to contact us immediately and let our customer service professionals handle the situation for you. There is no need to return your optic to the retailer.

*View back cover for lifetime warranty information.

PRIMARY ARMS OPTICS SLX® 3X MICROPRISM™

The SLx 3x MicroPrism is an all-new advanced optical system that combines the compact, lightweight size of a microdot with the durability and precision of a 3x magnified optic. The SLx 3x MicroPrism offers 13 illumination settings with AutoLive® motion-sensing on/off technology.

At its highest setting, the MicroPrism offers true Daylight Bright® illumination, while the low-power sleep mode extends runtime for 'always-on' storage. Because the SLx 3x MicroPrism uses an etched reticle with adjustable diopter, the user will always have a clear, crisp reticle image, even if they have severe astigmatism.

This package also includes our new ruggedized mounting system with industry standard mini-prism footprint, guaranteeing reliability and zero retention through heavy use and adverse conditions. Out of the box, this mount can be set for 8 different mounting heights and configurations, ensuring compatibility with any rifle system.

OPTIC FEATURES



AUTOLIVE®

Our motion-sense technology, AutoLive, greatly extends your battery life when storing optics with active illumination.



SHOCKPROOF

Our Shockproof optics are reinforced against impact, capable of facing the rigors of duty use.



DAYLIGHT BRIGHT®

Distinguished by powerful illumination, our Daylight Bright® reticles are strikingly bright, even in intense daylight conditions.



WATERPROOF

Our Waterproof optics are sealed for reliable function, even when fully submerged in water.



MULTI-COATED LENS

Our Multi-Coated Lenses are treated with a special finish to reduce reflections and increase light transmission.



SCAN TO SEE MORE PRIMARY ARMS OPTICS FEATURES

HOW TO ACHIEVE A CLEAR RETICLE PICTURE

Setting the diopter ring at the rear of the eyepiece is the critical first step to successful precision shooting. Looking at a featureless light background like a clear blue sky or blank wall, the reticle should appear sharp and crisp. If it does not, you need to make

adjustments by turning the ring. Look at the scope with quick glances and adjust until the reticle is clear at first glance. This is a one-time adjustment. Because everyone's eyes are different, the ideal adjustment will vary from person to person.

HOW TO SET RETICLE ILLUMINATION

Your reticle comes with a total of thirteen brightness settings, three of which are night vision compatible. The night vision settings are unable to be seen by the naked eye and can only be viewed through a separate night vision device. The indicator triangle makes it easy to determine your brightness setting.

The illumination knob can be turned infinitely in either direction, ensuring the shortest path to your desired illumination regardless of the current illumination setting. To turn illumination off, simply return the dial to the off (0) position.

HOW TO ZERO YOUR OPTIC

The optic is delivered in a centered position. Normally, this means that only small adjustments are necessary, providing that the base is properly aligned. Work your way to “zero” by adjusting each turret only a few clicks at a time. To adjust windage and elevation turn them as follows:

- a. To move the point of impact to the right, turn the windage adjustment screw clockwise.
- b. To move the point of impact to the left, turn the windage adjustment screw counterclockwise.
- c. To move the point of impact up, turn the elevation adjustment screw clockwise.

- d. To move the point of impact down, turn the elevation adjustment screw counterclockwise.

Every click will shift the position of the reticle by .25 MOA. The maximum total adjustment range for both windage and elevation is 80 MOA. If you suddenly encounter resistance, do NOT try to force the screw further, this can break the mechanism and render the sight unable to zero. Confirm zero by firing at least three shots at a zeroing target. After initial firing, check that the optic and mount are secure on your firearm. Check your impact points on the target to confirm accuracy and repeat until you are satisfied that the point of aim and the point of impact coincide at your desired range.

Optional risers allow you to customize optic height.

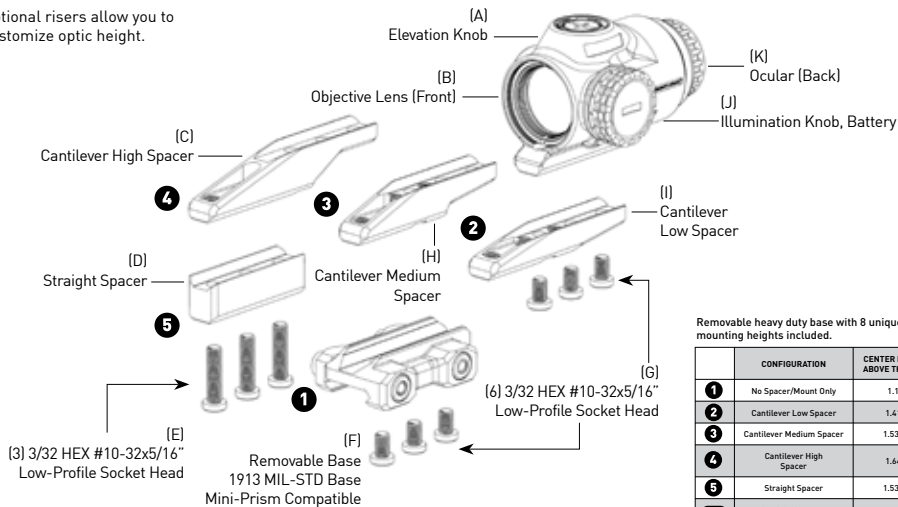

Removable heavy duty base with 8 unique mounting heights included.

	CONFIGURATION	CENTER HEIGHT ABOVE THE RAIL
1	No Spacer/Mount Only	1.1"
2	Cantilever Low Spacer	1.41"
3	Cantilever Medium Spacer	1.535"
4	Cantilever High Spacer	1.64"
5	Straight Spacer	1.535"
5+2	Straight Spacer + Cantilever Low Spacer	1.845"
5+3	Straight Spacer + Cantilever Medium Spacer	1.97"
5+4	Straight Spacer + Cantilever High Spacer	2.075"

Note: All these heights are measured using the included mount and may vary if using aftermarket mounts.

MOUNTING OPTIONS

The included 1913 MIL STD base as assembled in the box, positions the centerline of the 3x MicroPrism scope 1.41" above the receiver rail. With the base removed, the underside of the optic body is machined to be compatible with industry standard mini prism mounts. When mounting any base to the 3x MicroPrism Scope, the recommended torque the 10-32 screws to 25-30 in-lbs. Do not overtighten them!

A black security type screw is also located on the underside of the optic, this is the nitrogen gas purge port. Do not attempt to adjust that screw, or the nitrogen may vent from inside the optic, compromising function. For the same reason, do not attempt to adjust the spring cover also located under the optic on the left side.

The crossbolt located on the removable base uses a T25 Torx and should be tightened to 55-60 in-lbs. applying blue thread locker to the crossbolt threads.

1.1"



No Spacer/Mount Only

1.41"

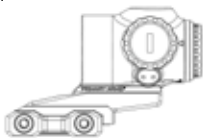

Cantilever Low Spacer

1.535"

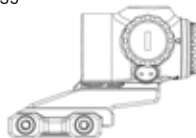

Cantilever Medium Spacer

1.64"

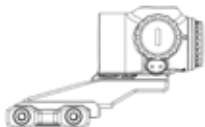

Cantilever High Spacer

1.535"



Straight Spacer

1.845"

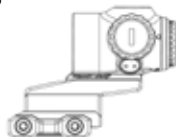

Straight Spacer +
Cantilever Low Spacer

1.97"

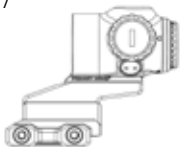

Straight Spacer +
Cantilever Medium Spacer

2.075"

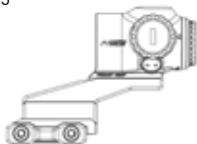

Straight Spacer +
Cantilever High Spacer

FOR EXAMPLE: 5+2 IS STRAIGHT
SPACER + CANTILEVER LOW SPACER AT
1.845" HEIGHT

BATTERY COMPARTMENT

The 3x MicroPrism Scope uses a single 3v CR 2032 battery. The battery cap is located on the left side and unscrews counterclockwise using a quarter or other

coin. The positive (+) side of the battery faces out towards the cap. Rechargeable batteries are not recommended and can potentially damage the electronics.

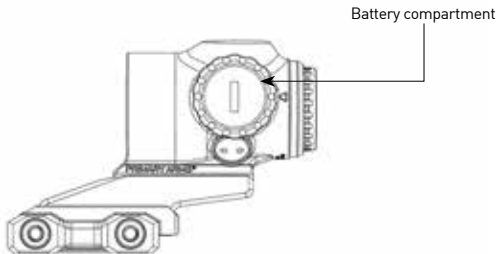

FEATURES

- Thirteen brightness settings: NV1, NV2 & NV3 are night vision compatible. Highest settings are daylight bright.
- Accommodation for anti-reflection devices (ARD) (sold separately).
- Includes AutoLive® battery-saving motion-sensing on/off technology.
- Hardware included for 8 different mounting heights.
- Aluminum alloy main body with hard coat anodizing.
- Fully nitrogen purged, IP67 waterproof and dust proof.
- Backed by our Lifetime Warranty.
- Uses One 3v CR 2032 Battery (included)
- 29,000-Hour Battery Runtime on Medium Illumination
- Industry Standard Mini Prism Mount Footprint
- Eye Relief: 2.7"
- Lens Covers also included; ARD option sold separately
- Lifetime Warranty

SLx 3X MICROPRISM SCOPE SPECIFICATIONS

Magnification: 3x	Click Value: .25 MOA	Total Elevation Adjustment: > 80 MOA
Objective Lens Diameter: 23 mm	Field of View: 38 feet 100 yards	Total Windage Adjustment: > 80 MOA
Eye Relief: 2.7"	Weight (with Battery, w/o Lens Covers): 7.95 oz	Battery: 3v CR 2032
Exit Pupil: 7.4 mm	Length (w/o Lens Covers): 2.95"	Warranty: Lifetime Warranty

LENS CARE

Please do not use any organic solvent such as alcohol or acetone on your optic. First, blow dust or any foreign objects off of the lens. Then, use a soft cotton or microfiber lens cloth to clean any

fingerprints or smears off the lens. Alternatively, you may use a piece of professional lens paper for further cleaning, if necessary.

REMEMBER: THE FOUR RULES OF FIREARMS SAFETY

- Treat every firearm as if it were loaded.
- Never let your muzzle cover anything you are not willing to destroy.
- Keep your finger off the trigger until your sights are on target.
- Be sure of your target and what is behind it.



WARNING: Always ensure your firearm is unloaded (chamber empty and magazine removed) before installing optics or accessories.



WARNING: Improper installation of firearm parts or accessories may result in death or serious personal injury. If you are not properly trained in the installation of these parts, have them installed by a gunsmith or armorer.

WARNING

- **INGESTION HAZARD:** This product contains a button cell or coin battery.
- **DEATH** or serious injury can occur if ingested.
- A swallowed button cell or coin battery can cause **INTERNAL CHEMICAL BURNS** in as little as **2 HOURS**.
- **KEEP** new and used batteries **OUT OF REACH OF CHILDREN**.
- **SEEK IMMEDIATE MEDICAL ATTENTION** if a battery is suspected to be swallowed or inserted inside any part of the body.



- Remove and immediately recycle or dispose of used batteries according to local regulations and keep away from children. Do NOT dispose of batteries in household trash or incinerate.
- Even used batteries may cause severe injury or death.
- Call a local poison control center for treatment information.
- Non-rechargeable batteries are not to be recharged.
- Do not force discharge, recharge, disassemble, heat above (manufacturer's specified temperature rating) or incinerate. Doing so may result in injury due to venting, leakage or explosion resulting in chemical burns.
- Ensure the batteries are installed correctly according to polarity (+ and -).
- Do not mix old and new batteries, different brands or types of batteries, such as alkaline, carbon-zinc, or rechargeable batteries. Remove and immediately recycle or dispose of batteries from equipment not used for an extended period of time according to local regulations.
- Always completely secure the battery compartment. If the battery compartment does not close securely, stop using the product, remove the batteries, and keep them away from children.



LIFETIME WARRANTY

Your Primary Arms SLx 3x MicroPrism Scope is covered by the Primary Arms Lifetime Warranty. If a defect due to materials or workmanship, or even normal wear and tear has caused your product to malfunction, Primary Arms will either repair or replace your product. You can find more details about our lifetime warranty at www.primaryarmsoptics.com.

Email: info@primaryarmsoptics.com

Toll-free at 855-774-2767

www.primaryarmsoptics.com



SCAN HERE for
more information
on these optics.



©Copyright 2024 PRIMARY ARMS, LLC
is a registered trademark of PRIMARY ARMS, LLC

For Patent Information go to <https://goo.gl/2z62aS>